

User Manual

Air Pump

Model : TS-10X (E2)

(X=0-9,A-Z)



UM-10X-EN V1.1

















Date: 20201015 Copyright by TRUE SOURCE Technology Co., Ltd.





Table of Contents

1. Safety Criteria/ Label content template	3
2. Warnings	5
3. Product Setup Contents	7
4. Product Features	8
5. Product description	9
6. Installation	10
7. Operating Principle	11
8. Air Pump Settings Contents	11
9. Routine Maintenance and Cleaning	13
10. Storage	13
11. Troubleshooting	14
12. Technical Specifications	16
13. EMC table	17
14. Warranty	23
15. Warranty Card	24
16. Contact	25

















1. Safety Criteria

Safety Symbol

	(EU) 2017/745 Medical Device Regulation (MDR)
	ISO 15223-1:2016 Ref no: 5.7.7 Medical Device
	ISO 15223-1:2016 Ref no: 5.1.1 Manufacturer
	ISO/DIS 20417 2019 Section 3.26 Single Patient - multiple use
	ISO 15223-1:2016 Ref no: 5.2.8 Do not use if package is damaged
	ISO 15223-1:2016 Ref no: 5.1.3 Date of manufacture
	ISO 7010-W012 : Warning, electricity
	ISO 15223-1:2016 Ref no: 5.1.7 Serial number
	ISO 15223-1:2016 Ref no: 5.1.6 Catalogue number
	ISO 15223-1:2016 Ref no: 5.1.9 Distributor
	ISO 15223-1:2016 Ref no: 5.1.2 Authorized representative in the European Community
	ISO 15223-1:2016 Ref no:5.7.10 Unique Device Identifier
	ISO 15223-1:2016 Ref no: 5.2.7 Non-sterile
	IEC 60417-5333 : TYPE BF APPLIED PART
	ISO 15223-1:2016 Ref no:5.3.7 Temperature limitation
	IEC 60417-5172 : Class II Equipment

	ISO 7000-0434A : Caution
	ISO 7010-M002 : Follow Instructions for Use
	EN 50419 - Marking of electrical and electronic equipment in accordance with article 11(2) of Directive 2002/96/EC Separate collection for waste of electrical and electronic equipment.
	IEC 60417-5008 : "OFF" (power)
	IEC 60417-5007 : "ON" (power)
No AP/APG	Non-applicable to the presence of flammable anesthetics or a high concentration of oxygen in the environment (AP or APG).
IP21	IEC 60529 : Protected against solid foreign objects of 12.5 mm Ø and greater; Protection against vertically falling water drops.

Label content template

REF TS- XXX (E2) Air Pump		TRUE SOURCE	
SN 220800001			
 220801			NO AP/APG
Input:220-240V AC, 50/60Hz	MD		
Fuse Rating:T1AL / 250V			
Power Consumption:10W max	TRUE SOURCE Technology Co.,Ltd.		
UDI 	TRUE SOURCE Technology Co.,Ltd.	EC REP	Obelis s.a.
(01) 0 4719875 12000 1 (11) 220801 (21) 220800001	4F., No.3, Lane 130, Minquan Road, Xindian District, New Taipei City 23141, TAIWAN		Boulevard Général Wahis 53 1030 Brussels, BELGIUM

Located at back of the air pump

2. Warnings

The product is only to be used as an auxiliary device. The manufacturer does not have the absolute responsibility and obligation to guarantee its full effects.

- Intended Use: For purpose of aiding the prevention of pressure ulcers and effective treatment of patients.
- The air pump only use with the air mattress that manufacturer provide together.
- This Air pump for medical equipment used.
- This Air pump is Continuous Operation.
- Do not modify this equipment without authorization of the manufacturer.
- Users to be considered:
 - A) Installation personnel – only by manufacturer trained and authorized technician for both device and mattress
 - B) Cleaning personnel – by professional healthcare personnel, general personnel or lay user
 - C) Maintenance/repair personnel – only by manufacturer trained and authorize technician
 - D) Operating personnel – Professional healthcare personnel, general personnel or lay user which matches the user profile.
- The equipment is intended for infant or adults by professional healthcare personnel, general personnel or lay user which matches the user profile.
- The patient may also be an intended operator.
- Please contact the manufacturer and local authorities if any serious incident has occurred.

- When getting severe back pain or feeling sick please consult healthcare profession and stop using this device.
- If there is any problem in setting up, using, maintaining, or to report unexpected operation or events, please contact the manufacturer or local distributor, do not try to repair the defective equipment.
- Potential allergic reactive may occur due to material sensitivity, do not lie on the mattress directly with no clothes on.
- Keep away from children, pests or pests when not using the equipment.
- Strangulation may be occurred due to excessive length of the power cord or the air tube, please place the cord and tubing where it can be easily disconnected and where unlikely to be in contact with children or pets.
- The age of the expected object is 20-60 years old, and the expected load is defined according to different mattress types, and the expected maximum is 250Kg.
- When you need to dispose of your products, please follow the guidance of your local authority or follow national requirements.
- This medical device can be used in home use environment and professional healthcare.

Caution:

- ✧ Do not open the Air Pump without guidance to prevent danger.
- ✧ Do not insert items into any opening of the Air Pump.
- ✧ Do not drop the Air Pump.
- ✧ Do not use the Air Pump in places exposed to water, liquids, oil, smoke, and flammable chemicals.
- ✧ Use fuses as marked: T1A / 250V.

- ✧ The device doesn't be used in the presence of flammable anesthetics mixture with air, oxygen or nitrous oxide environment (No AP/APG).
- ✧ Use a power cord that matches the voltage of the power outlet, which has been approved and complies with the safety standard of your particular country.
- ✧ To prevent the risk of electric shock, make sure power cord is unplugged from wall socket. To fully disengage the power to the unit, please disconnect the power cord from the AC outlet. The AC outlet shall be readily available and accessible.
- ✧ For plug-in equipment, the power outlet socket must be located near the equipment and must be easily accessible.
- ✧ The air pump must be placed on the foot end of the nursing bed, not on the head.
- ✧ Turn off the power switch on the side panel and unplug the power cord to ensure complete and safe shutdown of the device.

3. Product Setup Contents

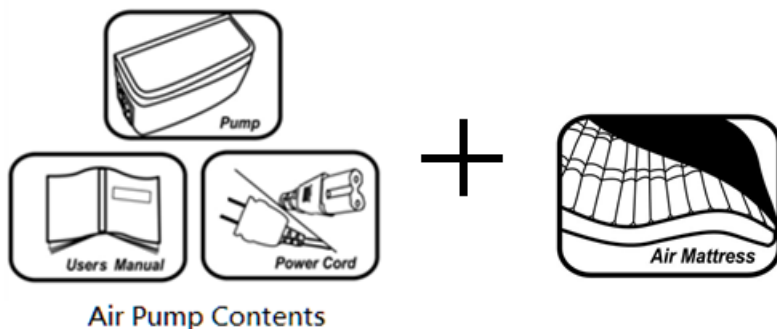

4. Product Features

Enhanced Design Features of the Air Pump

1. Air Pump integrated MPU is a “digital total control system” that has multiple smart options.
2. For hanging, the safest iron material is used for hanging hooks and its withstanding ability is far higher than plastic material.
3. For shock absorption, the deflation pump inside is equipped with a specially designed suspension shock absorption system and a foot mat is provided outside the unit in order to reduce the shock.
4. The compact size feature: The system is of a compact size, making it easy for placement and storage and taking into account the streamlined system appearance and practicality.
5. The cotton air filter is to be replaced outside. Therefore, the replacement can be done without opening the unit.
6. Double external fuse holders allow the unit to provide better safety protection.
7. The specialized power management with an independent power cord and a master power switch on the side can better ensure safety.

5. Product description

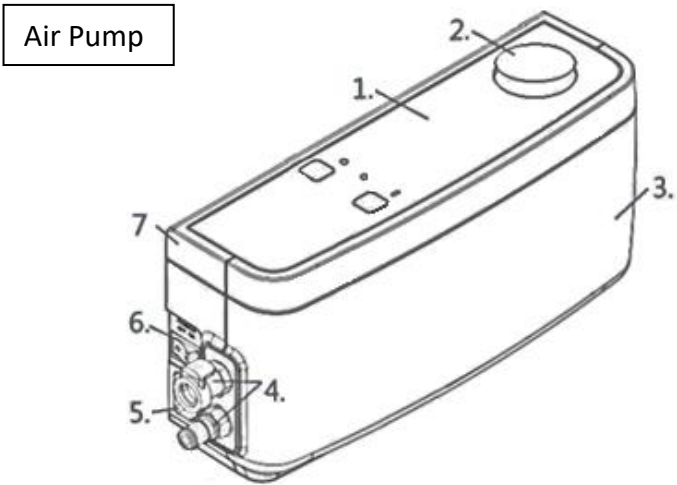

1. Control panel 2. Knob 3. Front Case 4. Air Outlet (Quick Coupling)
5. AC Inlet 6. Off/On Power Switch 7. Rear Case

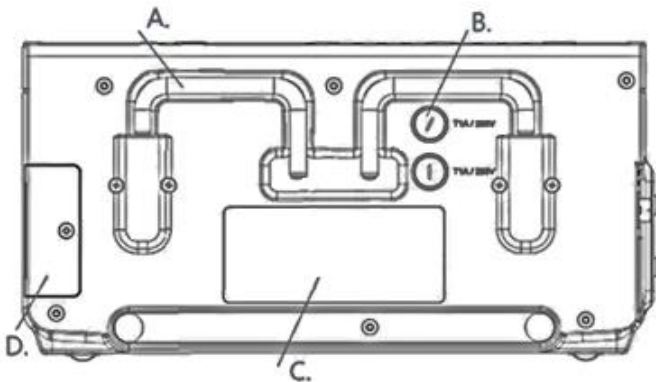

- A. Bed Hooks B. Fuses (T1A/250V) C. Label D. Air Filter

6. Installation

Step 1: Hang the Air Pump on the hospital bed at the feet end.

Step 2: Connect the hose at the feet end of the mattress to the air outlet of the Air Pump.

Step 3: Connector the power cord to the AC Inlet of the Air Pump.

Step 4: Plug the power cord of the Air Pump to a socket with power supply.

Step 5: Turn “ON” the power switch on the **side** of the Air Pump, and the green indicator turns on. Air starts to enter the hose in a few seconds.

Step 6: Weight setting Range “Knob” select 30 to 150 or comfort setting, See” Air Pump Settings Contents”

Step 7: Please wait until all the air cells are inflated by at least 2/3 of their volume (approx. 10mmHg) or for 30 minutes before the user is allowed to lie on the mattress.

Note: Ensure that the patient does not bottom out.

- ◎ **Power-off procedure: Turn off the side power switch first, and then unplug the power plug.**

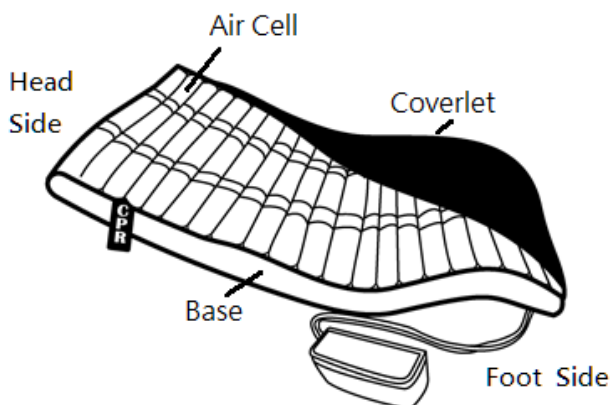

7. Operating Principle

This is an air pump using air compressor to fill up the pressure air mattress.

It is an air pump delivers air through air outlet to pressure air mattress by an air compressor which auto detects pressure by control PCB and stops/re-fills the pressure when deemed necessary.

Description

Use air pump to inflate or deflate the air cells, which can regularly and automatically change the distribution of body pressure.

8. Air Pump Settings Contents



(Representative Model: TS-106)

Button Function Are



1. **Weight Setting (kg) / Knob Control:**
Automatically provides a suitable alternating pressure according to the selected weight setting. The air mattress can be easily adjusted to a proper softness / hardness ranging from 30 to 150 Kg. (for 5") Or 1-10 comfort setting.

(ex. ranging from 30 to 150 Kg is for 5" mattress. Different loading weight is depending on manufacturer provided the mattress.)

2.  Auto Firm Mode (Nursing) Button:

During nursing, it can be difficult to turn a patient and nurse if the mattress is too soft. This can harden the mattress in the quickest way for easy nursing. However, after 30 minutes, the unit will forcefully resume the setting before the button is pressed in order to protect the patient from the risk of developing pressure ulcers because the mattress becomes too hard. Press the button when necessary.

3.  Audible Mute Button:

The alarm becomes audible when Low Pressure Alarm problem occurrence. The alarm can be muted with this button when it is necessary to turn off the function of alarm sound. To restore the audible alarm function, you have to reset the power switch.

4. Pressure Monitoring LED Indicator:

When the LED is flashing, this indicates that the pump is in the process of giving sufficient air to the mattress.

When the LED is lit on, this indicates that the pump is inflating the mattress according to the selected weight setting.

If the LED is not lit on, this indicates that the mattress has reached to an air pressure according to the selected weight setting.

9. Routine Maintenance and Cleaning

1. Thoroughly wipe down the dust or smear stuck on the exterior of the unit with a dry cloth and the 70%-75% ethanol. It is recommended to clean the pump once a week.. (Caregivers must wear gloves and masks and protected with disinfection.)
2. Replacement of the air cotton filter: it is recommended to replace the filter once a month. (Please purchase the filters from the dealer.)
3. Avoid using the unit when the air is poor. Do not smoke especially to prevent nicotine and greasy tar-like substance from entering the unit and resulting in the deterioration of internal pipes and the need for frequent replacement of the air cotton filter.

Suggestion: An air purifier can also be used to maintain the air quality.

10. Storage

How to store the Air Pump

1. It is necessary to turn off the power switch in side panel , unplug the power cord.
2. Disconnect the Air Pump and the power cord; disconnect the Air Pump and the hose at the feet end of the mattress.
3. Put the Air Pump and the power cord in the box and place in a dry place.
4. When the Air Pump is put away and not in constant use, it is better to switch it on at regular intervals to lengthen its life.
5. Follow the national requirement to dispose the Air Pump.

11. Troubleshooting

Symptom	Inspection Procedure	Possible Solution
1. Air Pump does not operate.	1.1) Check if the two ends of the power cord are safely connected to the Air Pump and the socket.	1.1) Confirm if the wall socket has power supply.
	1.2) Check if the power switch on the side of the Air Pump is switched to "ON".	1.2) If not, switch to "ON".
	1.3) Check if the fuse has burnt out or not properly installed.	1.3) Turn off the power and check the fuse.
2. Air Pump is working, but mattress is not inflating.	2.1) Check if air comes out of the Air Pump and if the connector is properly connected.	2.1) If the unit operates normally but no air comes out, it is possible that the Air Pump has something wrong inside and needs repair.
	2.2) Check if the CPR lid falls off.	2.2) Repair or replacement is needed if the lid is damaged.

	2.3) Check if the mattress connector is bent or falls off.	2.3) Repair or replacement is needed if the connector is deformed and cannot be restored or the material is not in its normal state.
	2.4) Check if the air hose is damaged.	2.4) Repair or replacement is needed if the air hose is damaged.
	2.5) Check if the air cotton filter is heavily soiled and the air is blocked.	2.5) Replace the filter if it is heavily soiled.
3. Bottom in contact with the overlay	3.1) Check weight setting.	3.1) Increase weight setting.
	3.2) Check if air leaks from the mattress.	3.2) Replace the air cells if damaged.
	3.3) Check if the air cotton filter is heavily soiled and the air is blocked.	3.3) Replace the filter if it is heavily soiled.
4. Others	Problems other than the above.	Contact the local distributor for handling.

12. Technical Specifications

Air Pump

Power Input : AC220-240V,50/60Hz or AC100-120V,60Hz

- ◆ Power Consumption: 10W max
- ◆ Fuse Rating: T1AL/250V
- ◆ Weight: 1.5Kg (approx.)
- ◆ Dimension: L26cm*W8cm*H13cm
- ◆ Air flow rate : 6-8 liter/min (approx.)
- ◆ Pressure Control Range: 20-50mmHg (+/-5)

Air Mattress

The air pump only use with the air mattress that manufacturer provided together. If in doubt, please contact the manufacturer for more information.

4"cells mattress loading weight: 30-120kg

5"cells mattress loading weight: 30-150kg

6"cells mattress loading weight: 30-180kg

8"cells mattress loading weight: 30-200kg / 30-250kg optional

Environment Condition:

	Usage	Transport	Storage
Temperature	5 °C ~40 °C	-25°C ~ 70 °C	-25 °C ~70 °C
Humidity	15% to 93%	- 25 °C without relative humidity control; and + 70 °C at a relative humidity up to 93 %, non-condensing	
Atmospheric Pressure	700hPa to 1060hPa	500hPa to 1060hPa	500hPa to 1060hPa

Air Pump Expected Service Life: 5 years.

13. EMC table

Guidance and manufacturer's declaration – electromagnetic emissions		
The model TS-100 is intended for use in the electromagnetic environment specified below. The customer or the user of the model TS-100 should assure that it is used in such an environment.		
Emissions test	Compliance	Electromagnetic environment – guidance
RF emissions CISPR 11		The model TS-100 uses RF energy only for its internal function. Therefore, its RF emissions are very low and are not likely to cause any interference in nearby electronic equipment.
RF emissions CISPR 11		The model TS-100 is suitable for use in all establishments, including domestic establishments and those directly connected to the public low-voltage power supply network that supplies buildings used for domestic purposes.
Harmonic emissions IEC 61000-3-2		
Voltage fluctuations/ flicker emissions IEC 61000-3-3		

Recommended separation distances between portable and mobile RF communications equipment and the model TS-100

The model TS-100 is intended for use in an electromagnetic environment in which radiated RF disturbances are controlled. The customer or the user of the model TS-100 can help prevent electromagnetic interference by maintaining a minimum distance between portable and mobile RF communications equipment (transmitters) and the model TS-100 as recommended below, according to the maximum output power of the communications equipment.

Rated maximum output power of transmitter W	Separation distance according to frequency of transmitter m		
	150 kHz to 80 MHz $d = 1,2 \sqrt{P}$	80 MHz to 800 MHz $d = 1,2 \sqrt{P}$	800 MHz to 2,5 GHz $d = 2,3 \sqrt{P}$
0,01	0,12	0,12	0,23
0,1	0,38	0,38	0,73
1	1,2	1,2	2,3
10	3,8	3,8	7,3
100	12	12	23

For transmitters rated at a maximum output power not listed above, the recommended separation distance in meters (m) can be estimated using the equation applicable to the frequency of the transmitter, where P is the maximum output power rating of the transmitter in watts (W) according to the transmitter manufacturer.
NOTE 1 At 80 MHz and 800 MHz, the separation distance for the higher frequency range applies.

NOTE 2 These guidelines may not apply in all situations.

Electromagnetic propagation is affected by absorption and reflection from structures, objects and people.

Guidance and manufacturer's declaration – electromagnetic immunity

The model TS-100 is intended for use in the electromagnetic environment specified below. The customer or the user of the model TS-100 should assure that it is used in such an environment.

Immunity test	IEC 60601 test level	Compliance level	Electromagnetic environment – guidance
Electrostatic discharge (ESD) IEC 61000-4-2	±6 kV contact ±8 kV air	±6 kV contact ±8 kV air	Floors should be wood, concrete or ceramic tile. If floors are covered with synthetic material, the relative humidity should be at least 30 %.
Electrical fast transient/burst IEC 61000-4-4	±2 kV for power supply lines ±1 kV for input/output lines	±2 kV for power supply lines ±1 kV for input/output lines	Mains power quality should be that of a typical commercial or hospital environment.
Surge IEC 61000-4-5	±1 kV line(s) to line(s) ±2 kV line(s) to earth	±1 kV line(s) to line(s) ±2 kV line(s) to earth	Mains power quality should be that of a typical commercial or hospital environment.
interruptions and voltage	<5 % UT (>95 % dip in UT)	<5 % UT (>95 % dip in UT)	

variations on power supply input lines IEC 61000-4-11	for 0,5 cycle 40 % UT (60 % dip in UT) for 5 cycles 70 % UT (30 % dip in UT) for 25 cycles <5 % UT (>95 % dip in UT) for 5 sec	for 0,5 cycle 40 % UT (60 % dip in UT) for 5 cycles 70 % UT (30 % dip in UT) for 25 cycles <5 % UT (>95 % dip in UT) for 5 sec	
Power frequency (50/60 Hz) magnetic field IEC 61000-4-8	3 A/m	3 A/m	
NOTE UT is the a.c. mains voltage prior to application of the test level.			

Guidance and manufacturer's declaration – electromagnetic immunity			
The model TS-100 is intended for use in the electromagnetic environment specified below. The customer or the user of the model TS-100 should assure that it is used in such an environment.			
Immunity test	IEC 60601 test level	Compliance level	Electromagnetic environment – guidance

<p>Conducted RF IEC 61000-4-6</p>	<p>3 Vrms 150 kHz to 80 MHz</p>	<p>Vrms</p>	<p>Portable and mobile RF communications equipment should be used no closer to any part of the model TS-100, including cables, than the recommended separation distance calculated from the equation applicable to the frequency of the transmitter.</p>
<p>Radiated RF IEC 61000-4-3</p>	<p>3 V/m 80 MHz to 2,5 GHz</p>	<p>V/m</p>	<p>Recommended separation distance $d = 1,2 \sqrt{P}$ $d = 1,2 \sqrt{P}$ 80 MHz to 800 MHz $d = 2,3 \sqrt{P}$ 800 MHz to 2,5 GHz</p> <p>where P is the maximum output power rating of the transmitter in watts (W) according to the transmitter manufacturer and d is the recommended separation distance in meters (m).</p> <p>Field strengths from fixed RF transmitters, as determined by an electromagnetic site survey, a should be less than the compliance level in each</p>

			<p>frequency range. b</p> <p>Interference may occur in the vicinity of equipment marked with the following symbol:</p> 
<p>NOTE 1 At 80 MHz and 800 MHz, the higher frequency range applies.</p> <p>NOTE 2 These guidelines may not apply in all situations. Electromagnetic propagation is affected by absorption and reflection from structures, objects and people.</p>			
<p>a Field strengths from fixed transmitters, such as base stations for radio (cellular/cordless) telephones and land mobile radios, amateur radio, AM and FM radio broadcast and TV broadcast cannot be predicted theoretically with accuracy. To assess the electromagnetic environment due to fixed RF transmitters, an electromagnetic site survey should be considered. If the measured field strength in the location in which the model TS-100 is used exceeds the applicable RF compliance level above, the model TS-100 should be observed to verify normal operation. If abnormal performance is observed, additional measures may be necessary, such as reorienting or relocating the model TS-100.</p> <p>b Over the frequency range 150 kHz to 80 MHz, field strengths should be less than V/m.</p>			

14. Warranty

◆ The warranty period for the Air Pump is **12 months** as of the purchase date of the product provided that the product is used in normal conditions. Repair outside the warranty period is subject to charge. The maintenance service for the product is warranted for 5 years. Upon the completion of maintenance outside the warranty period, an additional 6-month warranty period is provided. During this period, the same general terms and conditions of warranty apply.

◆ Only function failure repair is covered during the warranty period.

The warranty does not include general maintenance (e.g. replacement of the cotton filter, cleaning), setting adjustment or component renewal.

The warranty does not cover maintenance conducted by opening the Air Pump without authorization; careless dropping or use of the product other than for its intended purpose and repair of such is subject to charge.

Year of Manufacture:

The year of manufacture is in the device label.

Date of manufacture EX.  **220801**

The first two digits numbers indicate the year of manufacture, “22” meaning the year “2022”, and two digits followed by “08” meaning “August”, the month of manufacture.

15. Warranty Card

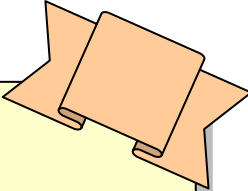

Warranty Card

Model: TS- 10X (E2) Air Pump
(X=0-9, A-Z)

Purchase date: _____ - _____ - _____

SN

(Distributor Signatures)

16. Contact



TRUE SOURCE Technology Co., Ltd.

Manufacturer address:

4F.,No.3,Lane 130, Minquan Road,
Xindian District, New Taipei City
23141, TAIWAN



Obelis s.a.

Boulevard Général Wahis 53
1030 Brussels, BELGIUM
Tel: +(32) 2. 732.59.54
Fax: +(32) 2.732.60.03
E-Mail : mail@obelis.net